

ESCOLA: \_\_\_\_\_

NOME: \_\_\_\_\_

PROFESSOR: \_\_\_\_\_ DATA: \_\_\_\_/\_\_\_\_/\_\_\_\_



# ADIÇÃO

1 - Observe.

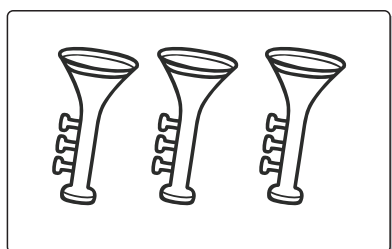
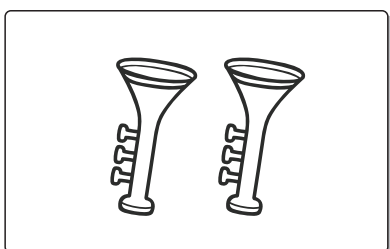
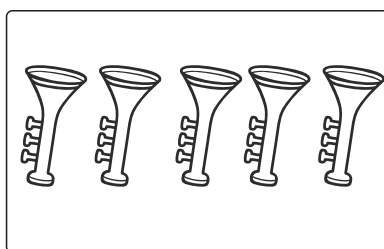
 +  = 

+  =

2 - Resolva.

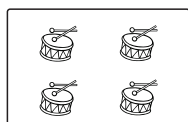
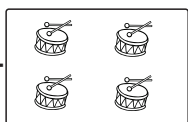
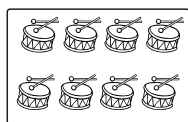
 +  = 

+  =

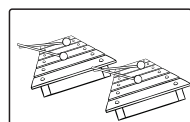
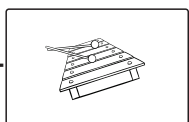
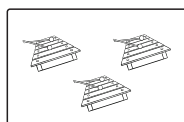
 +  = 

+  =

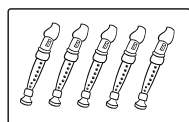
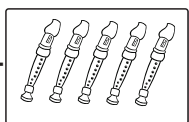
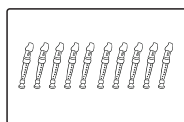
 +  = 

+  =

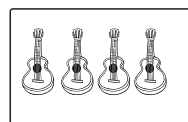
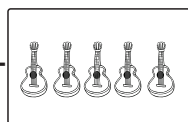
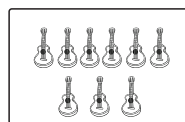
 +  = 

+  =

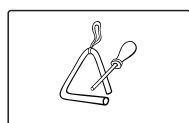
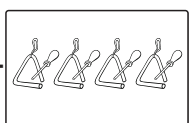
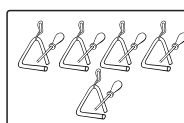
 +  = 

+  =

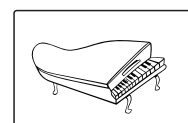
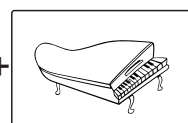
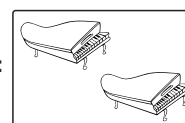
 +  = 

+  =